

3052-1T - RUBBER DAM CLAMPS / Uncini per diga

1T
winged, serrated

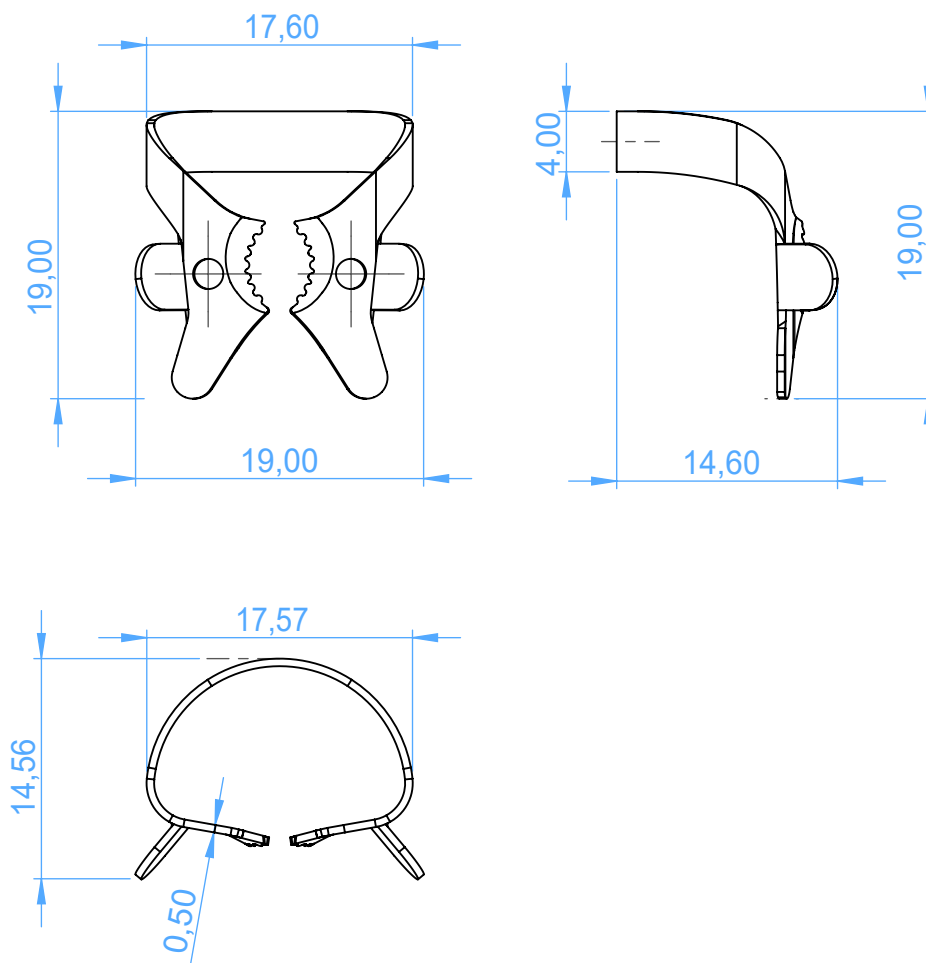

SCALE 2:1