

3052-14 - RUBBER DAM CLAMPS / Uncini per diga

14
winged

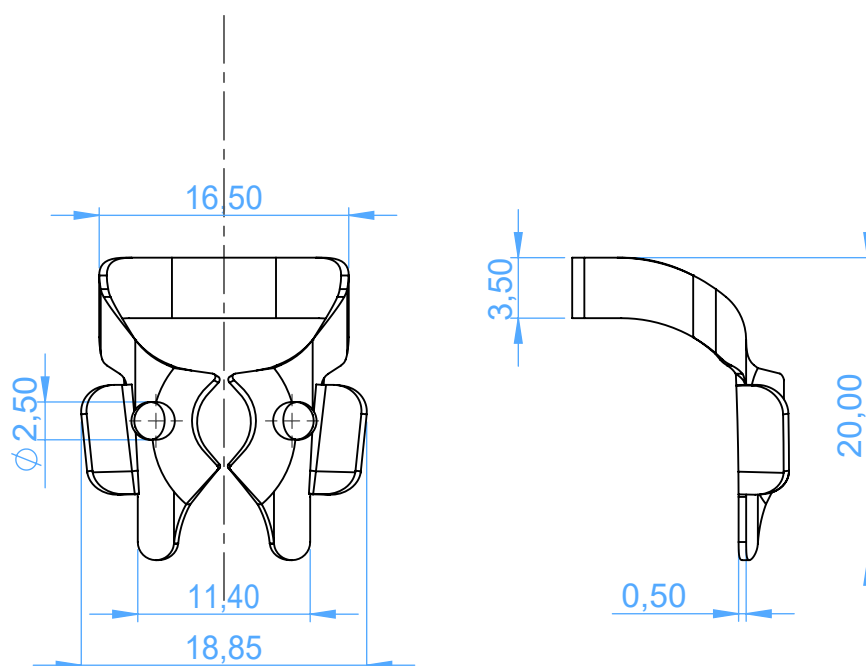

SCALE 2:1