

3051-202 - RUBBER DAM CLAMPS / Uncini per diga

202  
winged  
for large upper molars

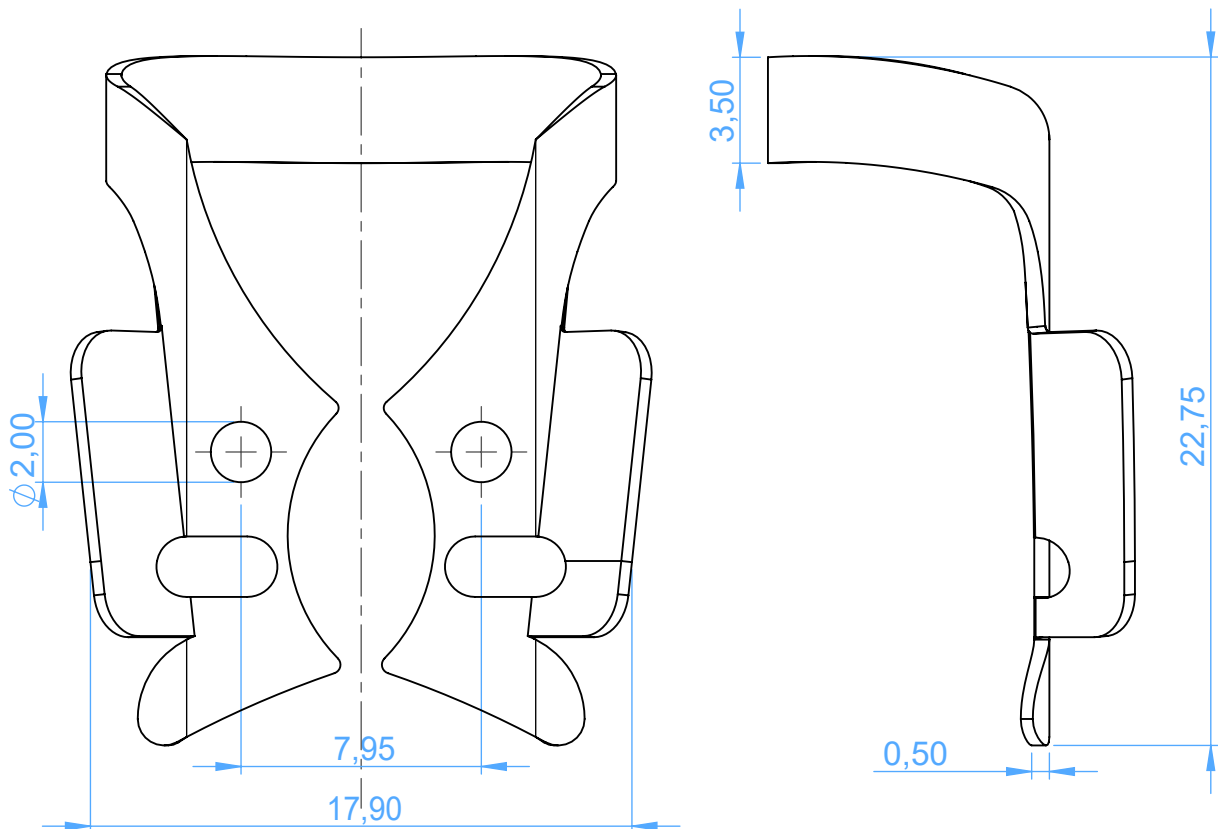

SCALE 4:1