

2806-L69 -
Portaimpronta forati in acciaio inox- edentuli / Perforated
stainless steel impression trays - edentulous

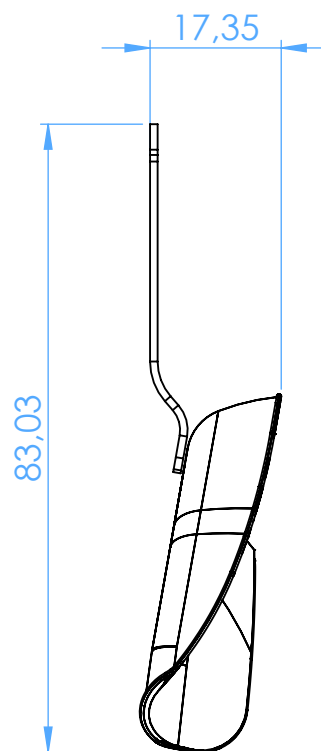
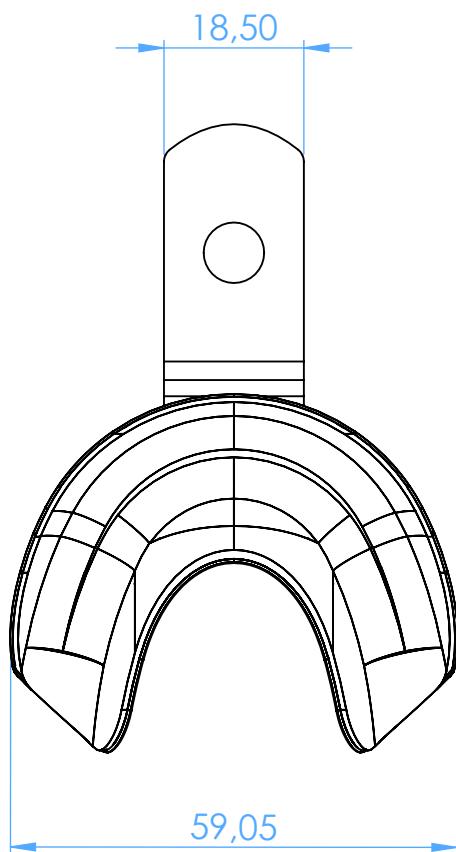

SCALE 1:1