

2804S-U4 -  
Portaimpronta forati in acciaio inox - PERMA-LOCK HIGH  
GRIP / Perforated stainless steel impression trays -  
PERMA-LOCK HIGH GRIP

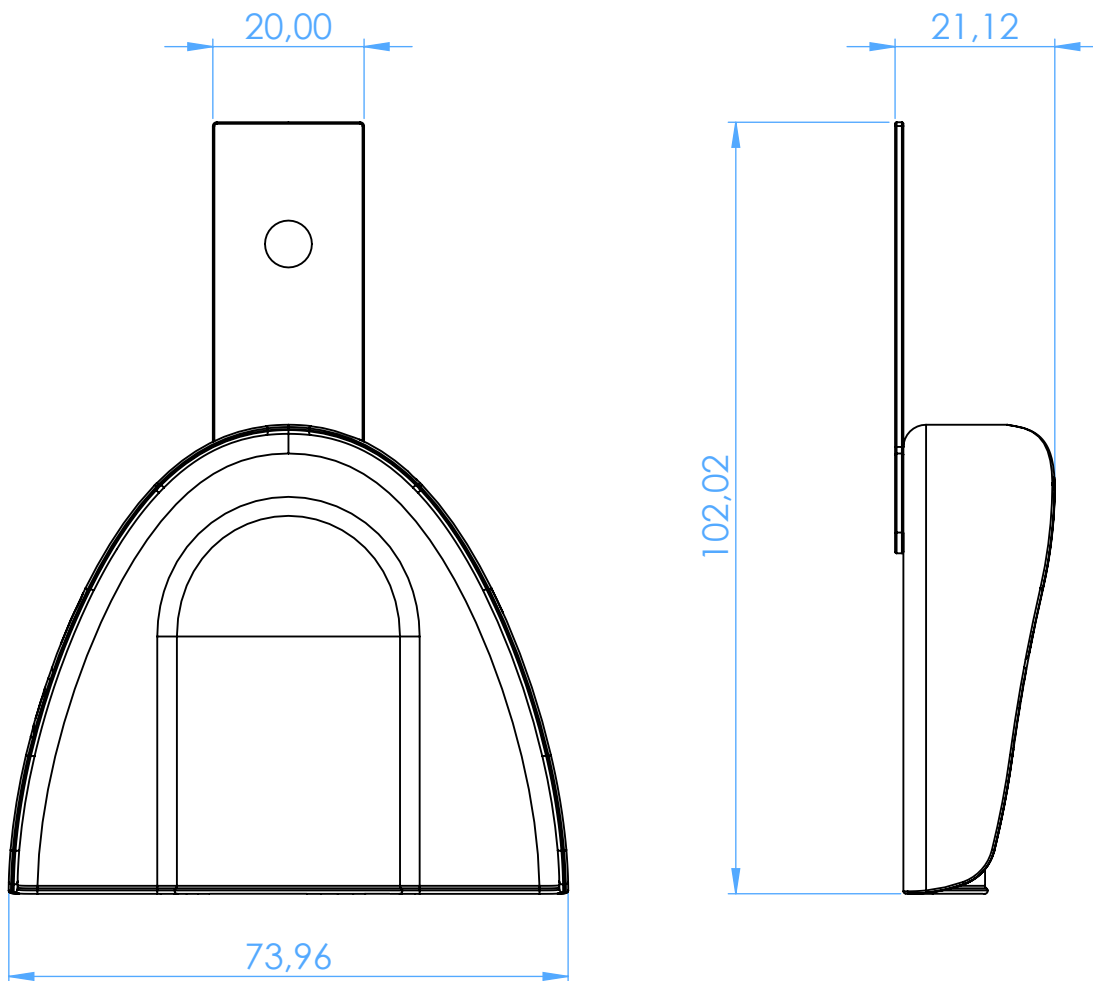

SCALE 1:1