

2804-U3 -
Portaimpronta forati in acciaio inox - PERMA-LOCK /
Perforated stainless steel impression trays - PERMA-LOCK

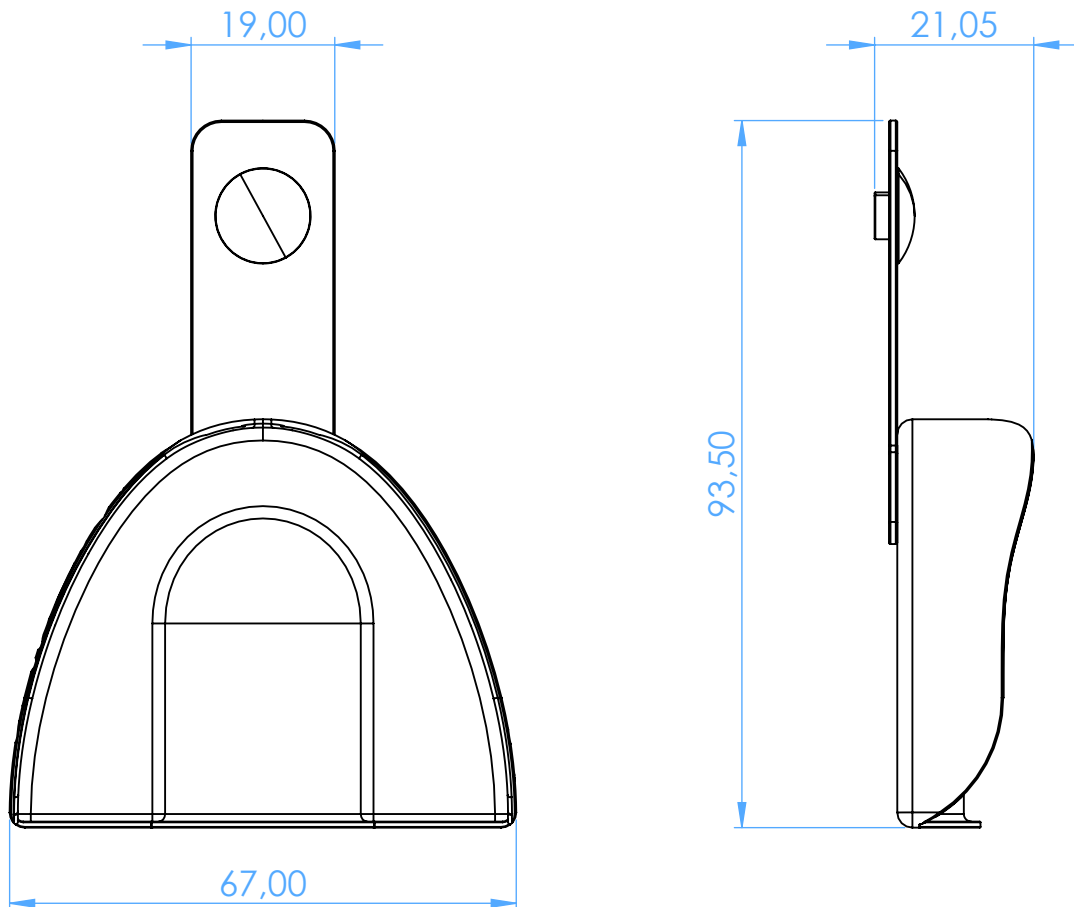

SCALE 1:1