

2804-L2D -
Portaimpronta forati in acciaio inox - PERMA-LOCK
/Perforated stainless steel impression trays - PERMA-LOCK

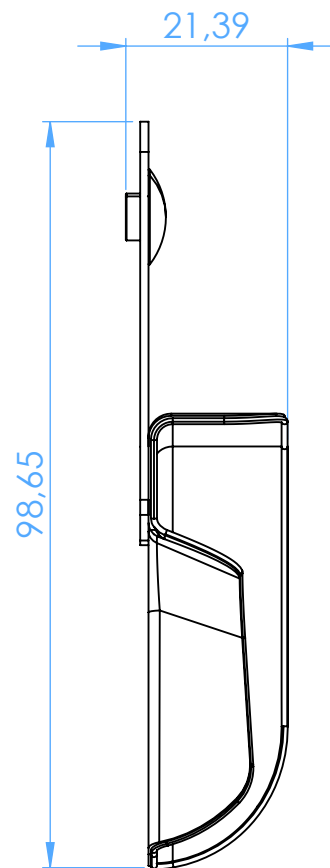
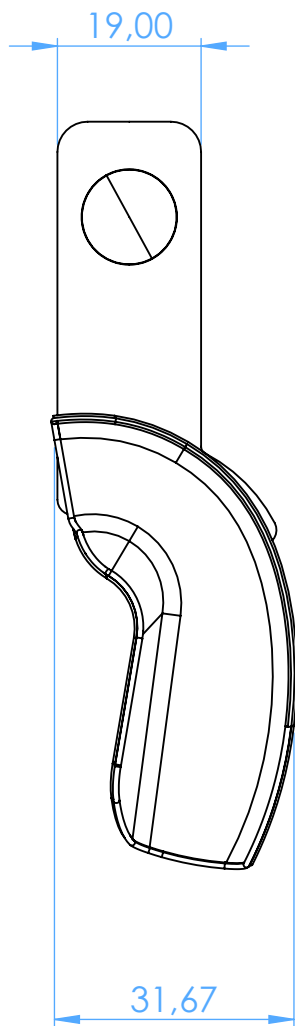

SCALE 1:1